

# HV1305C HV1305GC



[spectraprecision.com](http://spectraprecision.com)

**User Guide  
Bedienungsanleitung  
Manuel de l'utilisateur  
Gúia del usuario  
Guida per l'uso  
Gebruikershandleiding  
Käyttäjän opas  
Operatörshandbok**



HV1305GC



HV1305C

Exit of Laser Beam  
 Austritt Laserstrahl  
 Sortie du faisceau laser  
 Salida del rayo láser  
 Uscita del raggio laser  
 Uitgang van laserstraal  
 Lasersäteen poistuminen  
 Utgång från laserstrålen

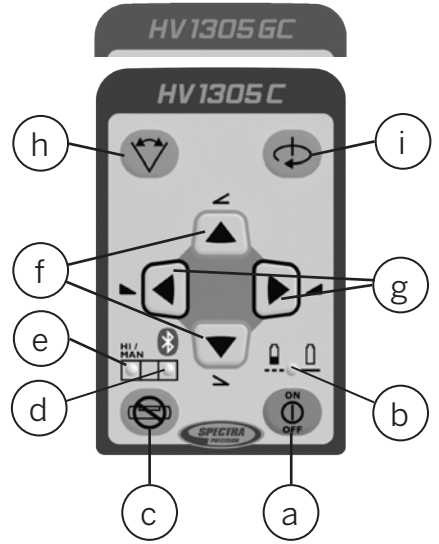
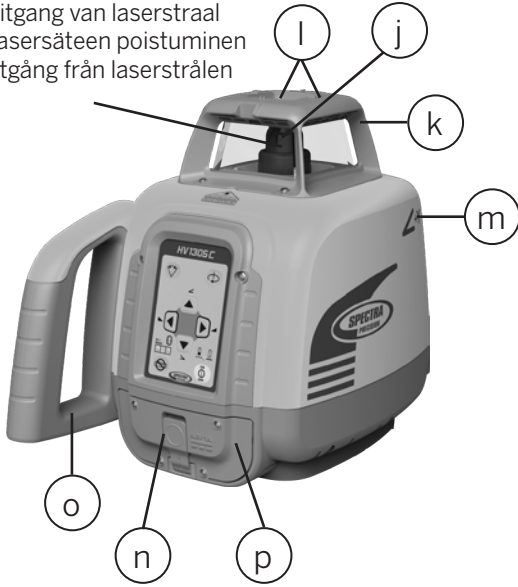

Exit of Laser Beam  
 Austritt Laserstrahl  
 Sortie du faisceau laser  
 Salida del rayo láser  
 Uscita del raggio laser  
 Uitgang van laserstraal  
 Lasersäteen poistuminen  
 Utgång från laserstrålen

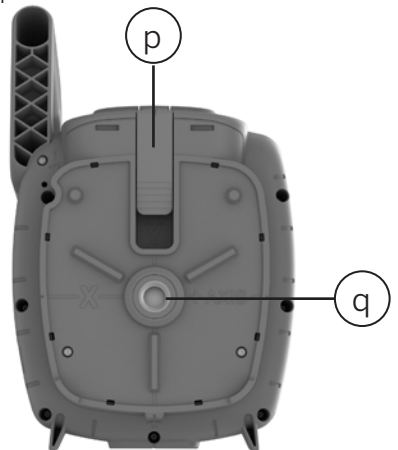
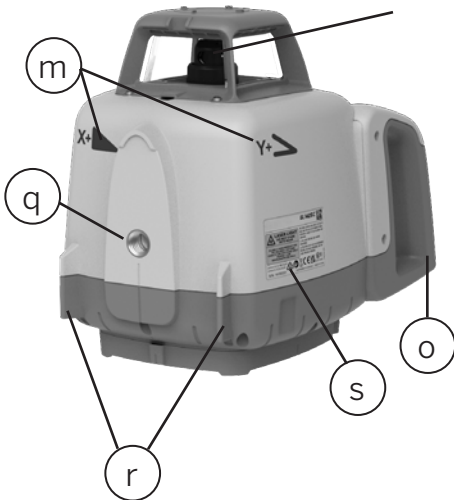





# Spectra Precision HV1305C/HV1305GC Horizontal/Vertical Laser

## User Guide

### Contents

<b>1</b>	<b>Introduction</b> .....	<b>7</b>
<b>2</b>	<b>Safety Instructions</b> .....	<b>7</b>
<b>3</b>	<b>Product</b> .....	<b>9</b>
3.1	General Description.....	9
3.2	Intended Usage.....	9
3.3	Product Components .....	10
3.4	RC1402 Remote Control.....	10
3.5	Batteries.....	11
3.5.1	Installing Batteries.....	11
3.5.2	Battery Status Indication.....	12
3.5.3	Recharging the Batteries.....	12
3.5.4	LED Indication on the Charger.....	12
<b>4</b>	<b>Laser Setup</b> .....	<b>13</b>
<b>5</b>	<b>Turn On/Off the laser</b> .....	<b>13</b>
<b>6</b>	<b>Menu Navigation via RC1402 only</b> .....	<b>14</b>
<b>7</b>	<b>Bluetooth® Connectivity</b> .....	<b>15</b>
<b>8</b>	<b>Horizontal Automatic, Self-leveling Mode</b> .....	<b>16</b>
<b>9</b>	<b>Manual Mode Horizontal</b> .....	<b>16</b>
<b>10</b>	<b>Rotation Speed</b> .....	<b>17</b>
<b>11</b>	<b>Pointing Mode</b> .....	<b>18</b>
<b>12</b>	<b>Scan Mode</b> .....	<b>19</b>
<b>13</b>	<b>Mask Mode</b> .....	<b>20</b>
<b>14</b>	<b>Standby Mode</b> .....	<b>21</b>
<b>15</b>	<b>Single Axis Slope Mode (Y or X axis)</b> .....	<b>21</b>
<b>16</b>	<b>PlaneMatch (Y-Axis) = Automatic Single Axis Slope</b> .....	<b>22</b>
<b>17</b>	<b>PlaneLok</b> .....	<b>24</b>
<b>18</b>	<b>Settings</b> .....	<b>27</b>
18.1	Pairing.....	27
18.1.1	Bluetooth.....	27
18.1.2	Radio.....	28
18.2	Shock Warning (HI-alert) .....	28
18.3	Backlight (RC1402 only).....	29
18.4	Sensitivity.....	30
18.5	Language.....	30
18.6	Radio Channel.....	30

<b>19</b>	<b>Info (only via RC1402)</b> .....	<b>32</b>
<b>20</b>	<b>Determining the Height of Instrument (HI)</b> .....	<b>35</b>
<b>21</b>	<b>Vertical Application</b> .....	<b>36</b>
21.1	Vertical Automatic Mode .....	36
21.1.1	Vertical Alignment / Laser Line Position .....	36
21.1.2	Line Scan .....	36
21.1.3	Automatic plumb down .....	37
21.1.4	Beam Plunge .....	38
21.1.5	PlaneLok in Vertical .....	38
21.2	Manual mode vertical .....	38
<b>22</b>	<b>Applications, Interior</b> .....	<b>39</b>
22.1	Acoustical ceilings .....	39
22.2	Drywall and partitions .....	39
<b>23</b>	<b>Use Receiver</b> .....	<b>40</b>
23.1	Pair the laser with HL760 receiver .....	40
23.2	Pair the laser with CR700 .....	41
<b>24</b>	<b>Remote Control RC1402</b> .....	<b>42</b>
24.1	Powering the RC1402 .....	42
24.2	Turning On/Off the radio remote control RC1402 .....	42
24.3	Pairing the remote control RC1402 with the laser .....	43
24.4	RC1402 Menu Navigation .....	43
<b>25</b>	<b>Troubleshooting</b> .....	<b>44</b>
<b>26</b>	<b>Check Accuracy</b> .....	<b>46</b>
26.1	Checking accuracy of the Y- and X Axis .....	46
26.2	Checking accuracy of the Z Axis (vertical) .....	46
<b>27</b>	<b>Service</b> .....	<b>46</b>
27.1	Technician Menu .....	46
<b>28</b>	<b>Protect the Unit</b> .....	<b>47</b>
<b>29</b>	<b>Cleaning and Maintenance</b> .....	<b>47</b>
<b>30</b>	<b>Protecting the Environment</b> .....	<b>47</b>
<b>31</b>	<b>Warranty</b> .....	<b>48</b>
<b>32</b>	<b>Technical Specification</b> .....	<b>49</b>
32.1	Technical Specification Laser HV1305C/HV1305GC .....	49
32.2	Technical Specification Laser Remote RC1402 .....	50
<b>33</b>	<b>Declaration of Conformity</b> .....	<b>50</b>
<b>34</b>	<b>UKCA</b> .....	<b>50</b>
<b>35</b>	<b>Electro-Magnetic Compatibility</b> .....	<b>51</b>

## 1 Introduction

Thank you for choosing one of the Spectra Precision Lasers from the family of precision lasers. This user guide is about the HV1305C/HV1305GC laser, which is an easy-to-use tool that offers accurate horizontal and vertical laser reference up to 4000 ft. (600m) diameter using a receiver. The HV1305C/HV1305GC is a self-leveling laser which provides a horizontal or vertical laser beam. It also provides a 90° layout and plumb beam transfer which can be used as a reference for several approaches in construction or other industries. The beams are designed to be visible in interior applications and can be detected by laser receivers for outdoor use or bright ambient light conditions.

## 2 Safety Instructions



For hazard-less and safe operation, read all the user guide instructions.



Example of the Serial Number Label

- Use of this product by people other than those trained on this product may result in exposure to hazardous laser light.
- The users of this product ensure they have read and understand the user guide.
- Always operate the unit in a way that prevents the beam from getting into people's eyes. Watch for reflections from surfaces like windows or flat metal surfaces.
- Do not remove warning labels from the unit.
- Do not use the product in an aggressive or explosive environment.
- If initial service is required, which results in the removal of the outer protective cover, removal must only be performed by factory-trained personnel.
- Using the laser or the accessories different than described in the HV1305C/HV1305GC user guide may result in unsafe operation.
- Charge only with specified chargers according to device manufacturer's instructions.
- Charge the batteries only within the specific temperature range; see user guide.
- The charger shipped with the HV1305C/HV1305GC is for indoor use only.
- Do not open the battery, dispose of in fire or short circuit; it may ignite, explode, leak or get hot causing personal injury.
- Do not open the rechargeable batteries cage.

- Rechargeable batteries or alkaline batteries shipped with the product may contain small amounts of harmful substances.
-  The products and batteries must not be disposed of with household waste. Dispose in accordance with all applicable federal, state, and local regulations.
- Keep the batteries away from children. If swallowed, do not induce vomiting. Seek medical attention immediately.
- Be sure to charge the battery before using it for the first time and after not using it for an extended length of time.
- There is a risk of electrocution when using leveling rods and poles near electrical installations such as power cables.
- Ensure the product is not damaged so that any unsafe usage can happen.
- Before starting your work, always check the accuracy of the product.
- Spectra Precision is not responsible for any inaccuracy that is caused by not reading the user guide and by any misuse of the product.
- The user of the product is responsible for checking the result for the measurement.
- Any local or national laws and regulations for the use of machines or products described in this document must be followed.
- Never put the laser or the accessories wet in the carrying case for storage.
- Reflections from some surfaces like windows or flat metal surfaces can lead to wrong receiver readings.
- After storage or transportation, the product acclimate to the ambient temperature before use of high accurate measurements.
- Remove the plug from the power outlet for disconnecting the laser from the power source.
- The used power outlet has to be close to the laser and requires easy and free access.

**Warning:** The HV1305C/HV1305GC is a class 2 or class 3 laser (IEC 60825-1:2014). This may depend on your choice of product. See laser warning label:



Pic 1 Laser Safety Label Class 2





Pic 2 Laser Safety Label Class 3

- Never look into the laser beam or direct it to the eyes of other people. This also applies at greater distances from the laser.

## 3 Product

### 3.1 General description

The laser may have been shipped to you with rechargeable NiMH battery pack or with alkaline batteries. In any case alkaline batteries can be used as a backup to power the laser at the job site. When alkaline batteries are used, the plus and minus symbols at the battery door indicate how to put the alkaline batteries into the battery compartment.

The rechargeable NiMH battery pack avoids mis-insertion by design. The rechargeable battery pack can be charged inside or outside the unit.

**Note:** Charging the rechargeable NiMH battery pack beyond the temperature mentioned in the technical specification chapter 32.1 may lead to decreased battery lifetime or undercharged batteries.

### 3.2 Intended Usage

The laser described in this user guide transmits a laser beam that can be used for measurement, for alignment or to reference the correct height of any job site requirement. The laser beam can be used horizontally, vertically or sloped. The laser can be detected by a laser receiver that might be part of the configuration. The configuration may also contain a remote control that is used to change settings of the laser (these are: rotation speed, line size, etc.). The laser is shipped with a charger that is designed to charge the rechargeable batteries of the laser.

The laser can be used for indoor and outdoor conditions.

### 3.3 Product Components

HV1305C/HV1305GC Laser (Refer to pages 2 and 3)

a	Power Button	Press for one second to turn on the Laser; press and hold for 2 seconds to turn off the laser
b	Battery LED	Shows the amount of battery charge
c	Manual/Standby Button	Quickly press and release activates/deactivates the manual mode
d	Leveling/Bluetooth® LED	Indicates the automatic level status of the Laser as well as Bluetooth® connection; in standard mode the LED color is green; in Bluetooth® advertising or connection mode the color is blue
e	Manual/HI-Warning LED	Indicates the manual level status or a laser HI alarm
f	Up and Down Arrow Buttons	
g	Left and Right Arrow Buttons	
h	Scan Button	Changes the line size
i	Rotation Speed Button	Changes the rotation speed
j	Rotor Head	
k	Sunshade	
l	Sighting Guides	
m	Slope Indication Marks	
n	Recharge Jack	
o	Handle	
p	Battery Door	
q	Tripod Mounts 5/8x11	
r	Stands	
s	Serial Number Label	
t	Rechargeable Battery Pack	B10
u	Universal Charger	CH10

### 3.4 RC1402 Remote Control (Refer to pages 2 and 3)

The remote control offers the same features and functions when used with HV1305C/HV1305GC laser that can be used with the laser itself and it provides even more options to control the laser and to change settings.

a	Power Button	Press for one second to turn on the RC1402; press and hold for two seconds to turn off the RC1402
b	Battery LED	Shows the amount of battery charge
c	Manual Button	Quickly press and release activates/deactivates the manual mode/single axis slope mode
f	Up/Down Arrow Button	
g	Left/Right Arrow Button	
h	Menu Button	Quickly press and release enters the Menu and can be used to return to previous menu position
j	Enter Button	Quickly press and release starts the selected mode
i	LCD	

## 3.5 Batteries

### 3.5.1 Installing batteries

Open the battery door. Insert alkaline batteries or the rechargeable battery pack into the housing according to the symbols on the housing or what the design of the battery pack allows you to do.

**Note:** DO NOT REMOVE RECHARGEABLE BATTERIES FROM THEIR CAGE AND INSTALL ALKALINE BATTERIES IN THE CAGE. SEVERE DAMAGE TO THE UNIT WILL RESULT IF CHARGING IS ATTEMPTED.

Close the battery door.

The HV1305C/HV1305GC can be used with a rechargeable NiMH battery pack, which is keyed to prevent mis-insertion. The way it is designed allows only the correct installation.

Alkaline batteries can be used as a backup.

Plus and minus symbols in the battery compartment indicate how to put alkaline batteries into the battery compartment.



### 3.5.2 Battery status indication

**WHY:** The customer needs to know the battery status when starting the work at the job site.

**WHAT:** The battery indication shows the remaining battery capacity for the rechargeable battery pack. The battery indication is also shown for alkaline batteries, but the true remaining battery lifetime depends on the battery brand. It also depends on the temperature and the job site conditions (wind, vibrations, etc.), the age of the batteries and how many recharge cycles the batteries have gone through.

**HOW:** When the battery LED (b) on the laser is off, the battery capacity is good. The battery LED shows the battery capacity by blinking once every second to show that the batteries are weak, and the remaining laser operating time is limited. The end user may consider charging the batteries. A solid battery LED indicates the batteries are empty and this means a remaining battery lifetime of app. 5 minutes. These times depend a lot on ambient temperatures, vibrations caused by machines or wind and the age of the used batteries.

On the RC1402 press the E button (j). The battery symbol will appear and is shown on the screen for app. 5 seconds. The symbol represents relative battery capacity: Empty, almost empty, good, and full (see pic 3).

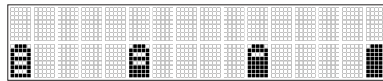

Pic 3 Battery symbols

### 3.5.3 Recharging the batteries

The battery LED (b) shows the approximate charge of the batteries. The LED will flash when battery voltage is low. When the battery LED blinks the remaining battery lifetime is approximately five minutes. The charger typically requires less than ten hours to charge empty rechargeable batteries fully. For charging, connect the plug of the charger to the recharge jack of the battery pack inside or outside of the laser.

New or long-time out-of-use rechargeable batteries reach their best performance after being charged and recharged five times. For indoor applications the charger can be used as a power supply for the HV1305C/HV1305GC.

The batteries can be charged within the laser or externally.

### 3.5.4 LED indication on the charger

Green LED flashes: Charging in progress.

Green LED permanent on: Charging has stopped.

Red LED permanent on: Error (batteries too cold, too warm, battery failure, etc.)

**Note:** The batteries should only be charged when the temperature is between 41°F and 104°F (5°C to 40°C). Charging at another temperature than specified may not start the charging process. Waiting for a temperature change may finally start the charging process when the temperature was the root cause for not charging.

**Note:** The charger has a security timer. The maximum charging time is twelve hours. After twelve hours the charger will always stop the charging process, independently from the charging status of the batteries.

**Note:** The batteries can be charged during laser usage.

## 4 Laser Setup

Position the laser horizontally or vertically on a stable platform, wall mount or tripod at the desired elevation. The laser recognizes automatically whether it is used horizontally or vertically when switched on.

It is required to position the laser within its self-leveling range; see chapter 32.1. When the laser is not positioned within the self-leveling range, the manual and leveling indicator LEDs (d and e) flash simultaneously and a warning sound is emitted. Take the appropriate action to set up the laser within the self-leveling range.

## 5 Turn On/Off the Laser

Turn on the laser pressing the power button (a) for one second. The LEDs (b, d and e) illuminate for one second.

The laser starts self-leveling at once. During the self-leveling process, the laser will not rotate and the laser beam as well as the leveling LED (d) will flash once every second. When the laser is switched on, it always starts in automatic, self-leveling mode. As soon as it is leveled, the rotor will start to spin, and the laser beam is continuously on.

The laser always starts with the last used rotation speed.

The leveling LED (d) will illuminate solid as long as the laser is in automatic mode but the Height-of-Instrument (HI) alert is not active. When the HI-alert is active the leveling LED flashes every four seconds and 'HI' appears in the display of remote control. The laser constantly monitors the level condition as long as the HI-alert is active.

Pressing and holding the E button (j) shows the actual rotation speed and the internal product temperature on the display of the remote control RC1402 (see pic 4). This temperature can be different from the ambient temperature.

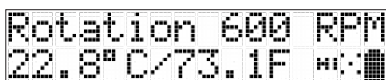

```
Rotation 600 RPM
22.8° C/73.1F [Battery Icon]
```

Pic 4 E button info

Info: How to change the settings for HI-alert (shock warning) and to understand what the HI-alert is good for, see chapter 18.2.

To turn Off the laser, press and hold the power button for two seconds.

**Note:** If the laser is out of its self-leveling range and remains out of it for more than 10 minutes, the unit shuts down completely.

## 6 Menu Navigation via RC1402 Only

WHY: All features of the HV1305C/HV1305GC can be accessed by a menu driven interface using the remote control RC1402. This is an intuitive way to operate the laser that is also easy to remember since it does not require certain two or three finger button presses.

WHAT: The remote control RC1402 has a keypad with some buttons that allows access to the menu. The menu offers only the features that can be selected depending on the set up either horizontally or vertically.

HOW: Press M button (h) to enter the menu and to see a function in the menu or to see a sub menu. Press E button (j) to start the function or to enter the submenu. Scroll within the menu or submenu with the UP/DOWN arrow buttons (f) and select the function by moving the arrow brackets >> <<. An up or down arrow at the right side indicates there are more features scrolling up or down. Press M button (h) to go back to the next level until the standard display is shown again.

Menu functions when HV1305C/HV1305GC set up in horizontal mode:

**>>Rotation<<**  
**>>Scan<<**  
**>>PlaneMatch<<**  
**>>PlaneLok<<**  
**>>Single Slope<<**  
**>>Mask Mode<<**  
**>>Settings<<**  
**>>Info<<**  
**>>Service<<**

Menu functions when HV1305C/HV1305GC set up in vertical mode:

**>>Rotation<<**  
**>>Scan<<**  
**>>PlaneLok<<**  
**>>Line Scan<<**  
**>>Beam Plunge<<**  
**>>Mask Mode<<**  
**>>Settings<<**  
**>>Info<<**  
**>>Service<<**

## 7 Bluetooth® Connectivity

**WHY:** Bluetooth® is an easy way to connect your laser with another device that also provides Bluetooth®. The HV1305C/HV1305GC provides Bluetooth® connectivity to connect your smartphone with the laser when using the Laser Remote App from Spectra Precision.

**WHAT:** The Laser Remote App is available on the Google Play Store and the Apple App store. Download the app from the store to your smartphone and install it.

**HOW:**

Option 1: When powering the HV1305C/HV1305GC, it is in connectivity mode for the first thirty seconds. During this time start the Laser Remote App. When starting the Laser Remote App for the very first time after installation, accept the EULA. If the EULA is not accepted, the App can't be used. It is also required to enable the GPS function on the smartphone. When the Bluetooth® connection was successful, the Laser status LED (d) will continue with blue color and the Laser Remote App shows the standard display of the HV1305C/HV1305GC.

Option 2 (requires RC1402 remote control): Press M button (h) on the remote control to enter the menu. Scroll to >>Settings<< and press E button (j) to enter the sub menu. Scroll to >>Pairing<< and press E button (j) to enter the sub menu. Scroll to Bluetooth and press E button (j) to start the connectivity mode for Bluetooth. The laser is in Bluetooth connectivity mode for 30 seconds.

Now start the Laser Remote App. When the Bluetooth® connection was successful, the Laser status LED (d) will turn blue, and the Laser Remote App shows the standard display of the HV1305(G)C.

**>>Settings<< → >>Pairing<< → >>Bluetooth<<**

**Note:** In manual mode the laser status LED (d) will continue with a short blinking in blue color every two seconds indicating the Bluetooth® connectivity.

## 8 Horizontal Automatic, Self-Leveling Mode

**WHY:** The laser HV1305C/HV1305GC provides a horizontal laser reference for the purpose of measurements on a job site or wherever this is needed. This laser reference can be used to measure any height above or below to achieve the correct elevation.

**WHAT:** By a rotating laser head, the laser provides a horizontal laser plane, which can be detected with a receiver. Under perfect ambient light conditions or using scan mode or 0 rpm, the laser beam can be seen. If not, it is recommended to use a receiver but not to change between human eye and receiver. This can result in different readings.

**HOW:** For this usage, the laser should be placed in a stable way. It is preferred to mount the laser on a tripod. The illumination of the green leveling LED (d) solid or flashing every four seconds confirms the automatic self-leveling mode. Powering on the laser HV1305C/HV1305GC always starts in automatic mode.

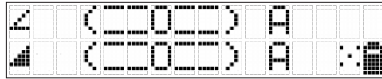

Pic 5 Horizontal automatic mode

The display shown in picture 5 is available via the remote control RC1402 only.

## 9 Manual Mode Horizontal

**WHY:** For some applications the user may require a non-level laser plane. This can be used to align non-level elevations or reference hubs. The laser can be sloped in both axes when in horizontal manual mode.

**WHAT:** When in manual mode the laser is not self-leveled. The laser does not use any sensors for the horizontal leveling or for the slope and there is no control for the slope accuracy and no warning for the Height of the Instrument (HI-alert).

**HOW:** In horizontal mode pressing the manual button (c) on the laser or on the remote control once changes the laser from automatic self-leveling mode to manual mode. Manual mode is indicated by the flashing (once every second) red LED (e).

In manual mode (horizontal), the Y-axis can be sloped by pressing the Up and Down arrow buttons (f) on the laser keypad or on the remote control. Additionally, the X-axis can be sloped by pressing the Left and Right arrow buttons (g) on the laser keypad or on the remote control.

Manual mode is indicated in the remote-control display by horizontal lines next to the axis symbols and the letter M, (see pic 6) as well as the blinking manual LED (e).

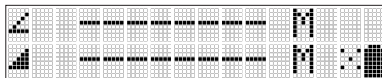

Pic 6 Manual mode horizontal

**Note:** The display shown in picture 6 is available via the remote control RC1402 only.



A manual inclination of the product using a tilting base, a tripod or similar accessory can be achieved.

To resume automatic self-leveling mode, press the manual button (c) three times again, so the green leveling LED (d) is on again and the laser self-levels. On the remote control the automatic mode display is shown, see pic 5.

**Note:** In horizontal manual mode, both the X and Y axis are in manual mode and there is no sensor that watches the axis. Even when the product is designed to avoid unforeseen drift as much as possible, there is the risk of a drift that the user must not overlook. It is mandatory that the user watches the laser plane in manual mode for any unforeseen behavior since there is no warning for the height of instrument or any changes caused by wind, vibrations, or temperature changes.

**Note:** Pressing the arrow buttons will start the sloping slowly and the sloping speed will increase over time. A short arrow button release and press will restart the sloping with the same speed since a long arrow button release will start the sloping slowly again.

**Note:** For manual mode in vertical see chapter 21.2.

## 10 Rotation Speed

**WHY:** Different applications or use cases may require different rotation speeds for the laser to rotate. Slow rotation speed increases visibility vs. high rotation speed. Some receivers may work better with a low or high rotation speed.

**WHAT:** The HV1305C/HV1305GC provides five different rotation speeds. These are 0, 10, 100, 200, 300 and 600 rounds per minute (rpm). At 0 rpm the beam stops automatically close to the +Y axis center position. The rotation speed can be increased by increments of 10 starting with 100 rpm.

**HOW:** Rotation speed can be selected using the Rotation button (i) on the laser as well as using the RC1402 menu.

Option 1: Repeatedly pressing the rotation button (i) on the laser toggles through 0, 10, 100, 200, 300, 600 rpm regardless of whether the unit is in automatic or manual mode.

Option 2: Press 'M' button on the remote control RC1402 to enter the menu. Using the Up/down buttons (f) scroll to and select >> Rotation<< (see pic 7). The selected function is marked in arrow brackets >> <<. When selected, press 'E' button to enter the 'rotation' menu. Using the up/down buttons (f) choose the rotation speed 0 rpm, 10 rpm, 100 rpm, 200 rpm, 300 rpm or 600 rpm (see pics 8 and 9). Press 'E' button to confirm and start the rotation speed.

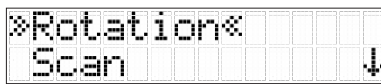

Pic 7 Rotation menu

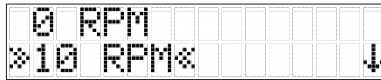

Pic 8 10 RPM choice

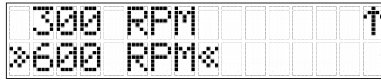

Pic 9 600 RPM choice

**Note:** At 10 rpm the HV1305C and HV1305GC provide a “jitter” line. During rotation the laser point jitters back and forth. This is not a malfunction; this is to increase the visibility of the rotating laser.

**Note:** At a minimum rotation speed of 100 rpm the rotation speed increases / decreases in 10 rpm increments up to 600 rpm by pressing the arrow buttons up or down (f) using the RC1402.

**Note:** When powering the laser, the laser starts with the last used rotation speed.

## 11 Pointing Mode

**WHY:** For indoor applications the laser is very often used without a receiver. Indoor light conditions may allow the usage of the laser without a receiver, nevertheless a non-rotating laser beam (0 rpm) increases visibility of the laser beam and so the laser beam can be used wherever it is needed over a very long distance. This might be helpful even on outdoor job sites. For this reason, the HV1305C/HV1305GC provides a sensitive electronic pointing mode so the laser beam can be pointed 360 degrees to any position where it is needed using the arrow buttons.

**WHAT:** Electronic pointing mode allows the alignment of the laser beam to the position where the usage of the laser beam is required. In both set ups, horizontal and vertical, the electronic pointing mode is available only in automatic mode. In manual mode the electronic pointing mode is not available.

**HOW:** In horizontal, automatic set up and at 0 rpm, press the arrow buttons Right/Left (g) to move the beam clockwise and counterclockwise. When set up vertically at 0 rpm, press the arrow buttons Up/Down (f) to rotate the laser beam clockwise / counterclockwise.

**Note:** When pressing the arrow buttons, the laser beam will start to move slowly and will increase the speed when you keep pressing the arrow button. A short button press release and re-press will continue with the same speed.

**Note:** In vertical mode and at 0 RPM, the laser always plumbs down automatically after approximately three seconds. See chapter 21.1.3.

## 12 Scan Mode

**WHY:** Mainly with indoor applications the visible line of the laser is used to do a marking. Here the scan mode helps for much more visibility under indoor ambient light conditions.

**WHAT:** The scan mode provides the pre-selected scan sizes of 5°, 15°, 45° and 90°, regardless of the unit is in automatic or manual mode. The scan lines can be moved to the working area where the marking needs to be done clockwise or counterclockwise. For the first four seconds, the scan line moves slowly than faster.

**HOW:**

**Option 1:** Quickly press and release the scan button (h) on the laser to toggle between the different scan sizes.

**Option 2:** Using the RC1402 press M button (h) to enter the menu. Scroll to >>Scan<<, press E button (j) to enter the submenu. Scroll down to the desired scan size. The >><< symbols mark the choice. Press enter to confirm the scan size.

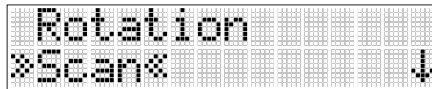

Pic 10 Scan Menu

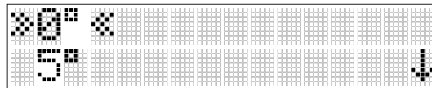

Pic 11 Scan Size

**Note:** When working in horizontal automatic mode, press and hold button Up/Down to increase / decrease the line size in 5° increments.

**Note:** Right/Left arrow buttons (g) moves the scan line clockwise or counterclockwise.

**Note:** When in vertical automatic mode, pressing and holding Up/Down arrow buttons (f) moves the scan line clockwise or counterclockwise.

**Note:** When set up vertically, pressing and holding Left/Right arrow button moves the scan line into the right or left direction regardless if in automatic or manual mode.

**Note:** The rotation control button (i) can be used to stop the scan mode.

## 13 Mask Mode

**WHY:** In some applications or on some job sites, the laser beam is not acceptable in all directions. Maybe the laser should not disturb the workers in a certain direction, or the laser may hit some reflective surfaces like windows or glossy metal surfaces. These surfaces can create laser reflections that will be detected by the laser receiver and will lead to wrong measurements and laser readings.

WHAT: The mask mode allows you to electronically shut off the laser in some sections so the laser would not create the conflicts described in the paragraph above. The HV1305C/ HV1305GC can shut off the laser beam in one, two or three sections. These sections are limited to the size of the lighthouse windows in the four axes. The status of the mask mode is shown on the standard display LCD of the remote control (see pic 16).

Option 1: To activate the mask mode on the + or – Y axis, press the Up or Down arrow button (f) and the manual button (c) within one second. To activate the mask mode on the + or – X axis, press the Left or Right arrow button (g) and the manual button (c) within one second.

Option 2: Press and release the M button (h) at the keypad of the remote control to enter the menu. Select >>Mask Mode<< (see pic 12). Depending on the sector the beam should be shut off, the desired sector can be selected. For selecting the sector, press and release one of the arrow buttons. When all sectors have been set, press E button (j) to store the mask sector selection until the unit will be turned off. Up arrow button will select the +Y axis, the Down arrow will select the -Y axis. The Right arrow button will select the +X axis and the Left arrow button will select the -X axis.

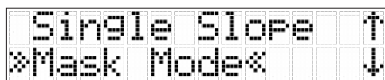

Pic 12 Mask mode menu

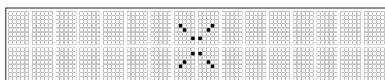

Pic 13 Display no mask mode

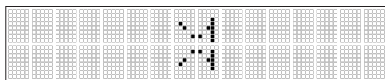

Pic 14 Mask mode +X axis

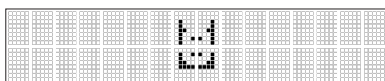

Pic 15 Mask mode +X, -Y, -X axis

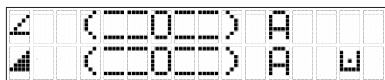

Pic 16 Mask mode on standard display

**Note:** Maximum three sectors can be shut off.

**Note:** The laser always powers up with the mask mode deactivated.

**Note:** The mask mode is available during rotation mode only.

## 14 Standby Mode

**WHY:** During the work on a job site there might be some time where the laser is not used (e.g. lunch break). Maybe there is the request or the need to save batteries. For this approach it is not recommended to switch off the laser since the new laser set up will be time-consuming and should be avoided.

**WHAT:** In fact, it is recommended to bring the laser into standby mode to save batteries. The self-leveling will be stopped and the beam will be turned off while the HI alert is still active. The display of the remote-control shows – Standby – (see pic 17) and the HI/MAN-LED (e) flashes red every five seconds. The standby mode ends automatically if the device orientation changes from horizontal to vertical or vice versa. When the laser is in Standby mode for more than 8 hours or when the batteries are empty, there is an automatic switch off.

**HOW:** Press and hold the manual button (c) at the laser or remote control for three seconds to bring the laser into the standby mode. Press and hold the manual button (c) again for three seconds to deactivate the standby mode and to restore full operation of the laser.

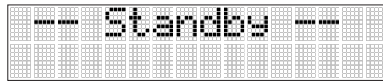

Pic 17 Standby Display

## 15 Single Axis Slope Mode (Y or X axis)

**WHY:** On some jobsites the fall or the rise of the ground between two existing elevations is not known. It is the goal to match the fall/rise of the ground or between the two existing elevations. Some examples of this are short ramps, driveways, etc.

**WHAT:** Single axis slope mode is available for either the Y axis or the X axis in the horizontal setup. Single axis slope mode is a manual way to slope the Y axis (or X axis) that will be in manual mode while the X axis (or Y axis) continues in automatic self-leveling mode.

**HOW:**

**Option 1:** At the laser or the remote control, starting at the automatic leveling status (d) LED is blinking, press the manual button (c) twice to activate the Y axis single slope mode or three times to activate the X axis single slope mode. The Y axis single slope mode is indicated by the simultaneously flashing red and green LEDs once every second. In the X axis single slope mode these LEDs flash every three seconds.

When the Y axis is in Single Axis Slope Mode, use the up and down arrow buttons (f) to slope the Y axis while the X axis remains in self-leveling mode.

When the X axis is in Single Axis Slope Mode use the left and right arrow buttons (g) to slope the X axis while the Y axis remains in self-leveling mode.

Option 2: At the remote-control press M button (h) to enter the menu. Scroll down to >>Single Slope<< and press the E button (j) to enter the sub menu. Choose >>MAN Y<< and press E button (j) to bring the Y axis into the Single Axis Slope Mode. The Y axis single slope mode is indicated by the simultaneously flashing red and green LEDs once every second. Scroll to >> MAN X<< and press E button (j) to bring the X axis into Single Axis Slope Mode. In the X axis single slope mode these LEDs flash every three seconds.

When the Y axis is in Single Axis Slope Mode use the up and down arrow buttons (f) to slope the Y axis while the X axis remains in self-leveling mode.

When the X axis is in Single Axis Slope Mode use the left and right arrow buttons (g) to slope the X axis while the Y axis remains in self-leveling mode.

**Note:** The axis that is in Single Axis Slope Mode, is in manual mode and there is no sensor that watches any drift for this axis. The user must ensure to watch any change in the laser set-up.

## 16 PlaneMatch (Y-Axis) = Automatic Single Axis Slope

The PlaneMatch function requires a remote control RC1402 or the laser remote app.

**WHY:** On some jobsites the fall or the rise of the ground or between two existing elevations is not known. It is the goal to match the fall/raise of the ground or between the two existing elevations. This will eliminate the need for complex calculations and will avoid errors. PlaneMatch is an easy way to connect two reference points with a constant laser beam that can be used as a reference.

**WHAT:** Using the HL760 or CR700, the automatic PlaneMatch function can match the current fall/rise and will end in a sloped laser plane. The feature will typically work to a maximum distance of 80 m (240 ft.). As the result of the PlaneMatch functionality, the laser will be in Single Axis Slope mode. This means that the Y axis is in manual mode and the X axis is in automatic self-leveling mode.

The PlaneMatch mode can be activated in horizontal automatic mode only.

The PlaneMatch function is available only in the Y-axis.

**HOW:**

- 1.) Set up the laser over the first reference point, see pic 22.
- 2.) Attach the HL760 / CR700 receiver to a grade rod. Place the rod next to the laser and adjust the height of the receiver next to the laser until the laser receiver is on-grade. Now the on-grade position of the receiver has the same elevation as the laser beam (=height of instrument HI), see pic 22.
- 3.) Without changing the receiver's elevation on the rod, position the rod at the second reference point facing the front of the receiver towards the laser, see pic 22.
- 4.) Use the sighting guides on the top of the laser to align the laser to the receiver. Turn the laser on the tripod until it is roughly aligned to the receiver's position.

- 5.) Press and release the M button (h) and select >>PlaneMatch<< (see pic 18).
- 6.) Press and release E button (j) to open the PlaneMatch submenu; confirm Y axis by pressing the E button (j) again to start the PlaneMatch function (see pic 19).
- 7.) The laser starts to search for the receiver. The remote control display shows a flashing “PM” and the HL760 / CR700 display shows a flashing “-GM-” (see pic 20 and 21) during the time the laser is searching and adjusting the beam to the on-grade position. When PlaneMatch has been completed, the HL760 / CR700 goes back to the standard elevation display. The remote control will display the final status of the laser that is now in single axis slope mode for the Y axis. The laser shows its status by simultaneously flashing red and green LEDs (once a second). The Y axis is in manual mode and the X axis is in automatic mode.
- 8.) Exiting PlaneMatch can be done by pressing the Manual button (c) twice where the unit always goes back to automatic mode.

**Note:** When the function PlaneMatch is complete, the laser will be in single axis slope mode for the Y axis. This means, the Y axis is in manual mode and the X axis is in automatic self-leveling mode. There might be no warning for changes in the Y axis when there is a drift of the laser plane. The user must ensure to watch any change in the laser set-up.

**Note:** The HL760 / CR700 can be removed from their position to take measurements on the job site.

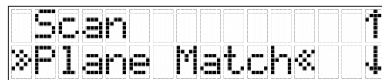

Pic 18 PlaneMatch Menu



Pic 19 PlaneMatch Submenu

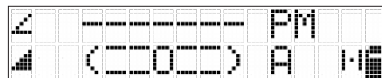

Pic 20 PlaneMatch laser display

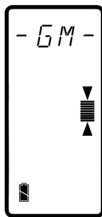

Pic 21 PlaneMatch (GradeMatch) HL760/CR700 display

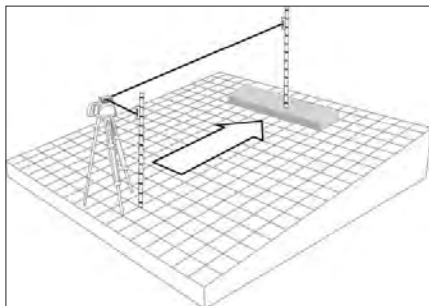

Pic 22 PlaneMatch Setup

**Note:** When started in manual mode, the laser will switch into single axis slope mode.

## 17 PlaneLok

The PlaneLok function requires a remote control RC1402 or the laser remote app.

**WHY:** On some job sites there is the need to lock the laser onto a fixed position. This might help with high accuracy job site requirements or to overcome job site circumstances like vibrations, moving objects, or temperature drift.

**WHAT:** A radio in the laser and the receiver communicates and keep the laser beam locked to a fixed elevation or direction horizontally as well as vertically. Using the PlaneLok mode the HV1305C/HV1305GC connects a first elevation reference point, where the laser is positioned with a second elevation reference point where the laser receiver must be positioned, with the correct fall or rise. The PlaneLok mode will automatically guide the laser beam of the Y axis to the on-grade position of the HL760 / CR700 receiver. As a result of the PlaneLok function, the laser is sloped in the Y axis while the X axis will remain in the automatic self-leveling mode. The HL760 / CR700 receiver continuously shows the on-grade position of the laser. It is recommended to leave the HL760 / CR700 at the fixed position and to use another receiver to do the measurements. It is not recommended to switch the laser into manual mode and to remove the HL760 / CR700 receiver.

**HOW:** The PlaneLok mode can be activated either in horizontal automatic mode or in vertical automatic and manual mode.

In horizontal mode the PlaneLok mode is only available on the Y axis. In vertical mode the PlaneLok is available only in X axis.



**Note:** When used in vertical mode, the receiver must be placed with the photocell on the bottom side.

- 1.) Set up the laser over the first reference point (see pic 29).
- 2.) Attach the HL760 / CR700 receiver to a rod. Place the rod next to the laser and adjust the height of the receiver next to the laser until the laser receiver is on-grade. Now the on-grade position of the receiver has the same elevation as the laser beam (see pic 29).
- 3.) Without changing the receiver's elevation on the rod, position the rod at the second reference point facing the front of the receiver towards the laser (see pic 29).
- 4.) Use the sighting guides on the top of the laser to align the laser to the receiver. Turn the laser on the tripod until it is roughly aligned to the receiver's position.
- 5.) Press and release the M button (h) on the remote control to enter the menu and scroll to mark >>PlaneLok<< (see pic 23).
- 6.) a) Press and release E button (j) to open the PlaneLok submenu. Select >>PL Y<< to confirm PlaneLok for the Y axis when set up horizontally and press E button (j) to start PlaneLok (see pic 24).  
b) When set up vertically, press and release E button (j) to open the PlaneLok submenu. Select >>PL X<< for the X axis (see pic 25). Press E button (j) to start PlaneLok.
- 7.) The laser starts to search for the receiver. The display of the remote control as well as the HL760 / CR700 display shows the flashing -PL- during the time the laser is searching and adjusting the beam to the on-grade position, see pic 26 and pic 27. When PlaneLok is complete, -- PL-- stops flashing at the HL760 / CR700 and the laser remote display.

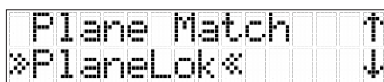

Pic 23 PlaneLok menu

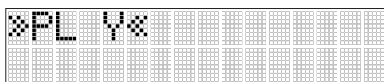

Pic 24 PlaneLok horizontal or vertical Y axis

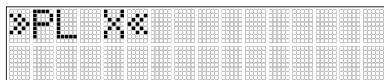

Pic 25 PlaneLok vertical X axis

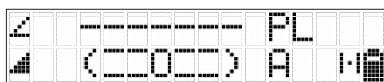

Pic 26 PlaneLok display



Pic 27 HL760 PlaneLok display

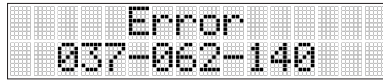

Pic 28 Error code blocked beam

**Note:** For getting the best radio performance and a longer operating range set up the HL760 / CR700 at least 1 m (3 ft.) above the ground.

**Note:** In PlaneLok mode the laser continues to servo to the receiver's signals. Any loss of signal over an extended period of time (1 minute) causes the laser to go into HI-alert condition (beam turns off, rotor stops, and a warning message occurs at the LCD of the laser remote). PlaneLok mode can be reactivated after the Error message, see pic 28, has been deleted with the E button (j). Exiting of PlaneLok can be done by pressing Manual button (c) on the laser or remote control, any button on the HL760 / CR700 or ESC in the laser remote app.

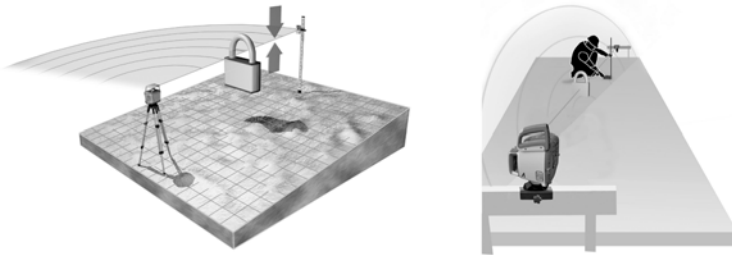

Pic 29 PlaneLok horizontal and vertical

## 18 Settings

The settings menu requires the remote control RC1402.

WHY: Different use cases, job sites, users and applications require different settings for the laser.

WHAT: The chapter >>Settings<< describes how the laser can be adjusted according to the requirements of the job application or according to the own preference how to work.

HOW: Press the M button (h) on the remote control to enter the menu. Scroll to >>Settings<<, press the E button (j) to enter the settings menu (see pic 30). With the arrow buttons UP/DOWN scroll to the sub-menus.

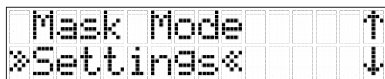

Pic 30 Settings menu

## 18.1 Pairing

### 18.1.1 Bluetooth

WHY: Bluetooth® is an easy way to connect your laser with another device that also provides Bluetooth®. The HV1305C/HV1305GC provides Bluetooth® connectivity to connect your smartphone with the laser when using the Laser Remote App.

WHAT: The HV1305C/HV1305GC provides Bluetooth® connectivity to connect the laser directly with your smartphone using the Spectra Precision® Laser Remote App. The Spectra Precision® Laser Remote App is available on Google Play Store as well as on the Apple app store. Download the app from the store to your smartphone and install it.

HOW:

Option 1: When powering the HV1305C/HV1305GC it is in connectivity mode for the first thirty seconds. During this time start the Laser Remote App. When starting the Laser Remote App for the very first time after installation, accept the EULA. If the EULA is not accepted, the App can't be used. It is also required to enable the GPS function on the smartphone. When the Bluetooth® connection was successful, the Laser status LED (d) will continue with blue color and the Laser Remote App shows the standard display of the HV1305C/HV1305GC.

Option 2 (only via RC1402): Press M button (h) on the remote control to enter the menu. Scroll to >>Settings<< and press E button (j) to enter the sub menu. Scroll to >>Pairing<< and press E button (j) to enter the sub menu. Scroll to >>Bluetooth<< and press E button (j) to start the connectivity mode for Bluetooth. The laser is in Bluetooth connectivity mode for 30 seconds. Now start the Laser Remote App. When the Bluetooth® connection was successful, the Laser status LED (d) will turn blue, and the Laser Remote App shows the standard display of the HV1305(G)C.

**>>Settings<< → >>Pairing<< → >>Bluetooth<<**

### 18.1.2 Radio

WHY: Radio communication is needed for the remote control to control the laser and for the receiver to do some of the automatic features. When the laser has been shipped with the remote control and the receiver, both are usually paired with the laser.

Nevertheless, for some reason sometimes this radio pairing is lost. When the remote control or receiver has been bought separately from the laser, there is no established pairing.

**WHAT:** The radio connectivity must be set up to ensure radio communication between the laser and the remote control and/or the receiver.

**HOW:** Start with the laser being off. Press and hold the Manual button (c) and power the laser with the on/off button (a). The laser is now in radio pairing mode for six seconds.

Within these six seconds bring the remote control (see chapter 24) or the receiver (see chapter 23) into pairing mode as well.

**Note:** When pairing the receiver, it is recommended to start with the receiver.

## 18.2 Shock Warning (HI-alert)

**WHY:** The Shock Warning (HI-Alert) function controls the **H**eight of your **I**nstrument on the job site. Any changes of the Height of Instrument by bumping a tripod leg or by sinking of a tripod leg will be monitored. This ensures the accuracy of your work. Usually, the system does not see a constant change of the height of all three tripod legs at the same time but a change of tripod height, which causes a tilt of the tripod height. The Shock Warning will warn of a change of tripod height of typ. 3 mm (1/10 in).

During the setup of the laser, the Shock Warning is not activated since this may result in a constant alarm when the height and position of the laser or tripod is changed. This is why the HV1305C/HV1305GC provides a delay time for the Shock Warning. The delay time for Shock Warning should allow the user a certain amount of set-up time without any alarm of height changes. The Shock Warning would now be active when the delay time is over and when the set-up has been completed within this time frame.

**WHAT:** When entering alert mode, the rotation stops, the laser beam turns off, a warning sound is heard, and the HI/MAN LED (e) flashes every 4 seconds and HI symbols appears at the right corner on the main display in the app. The user now must check the setup of the laser and eventually must reset the laser to ensure the initial situation is achieved again. To achieve this, the user has created some elevation reference in the very beginning. To allow for the set-up, the HV1305C/HV1305GC provides three options for the Shock Warning (HI-Alert) delay time. Under the remote-control menu item HI-Alert the user can switch off the Shock Warning (not recommended) or can change the delay time to activate the Shock Warning. This delay time can be changed to 30 seconds or five minutes (default).

**HOW:** On the remote control press the M button (h) to enter the menu. Scroll to >>Settings<<, press the E button (j), scroll to >>HI-Alert<< (see pic 31) press E button (j) to open the HI-alert submenu. Choose delay time 5 min (default) (see pic 32) or 30 seconds or HI-Off (see pic 33) by scrolling to the option and confirming by pressing the E button (j) on the remote control or in the laser remote app when used.

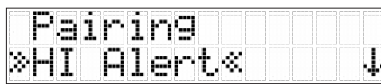

Pic 31 HI Alert menu

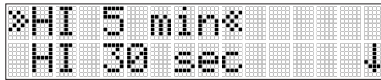

Pic 32 HI Alert 5 min

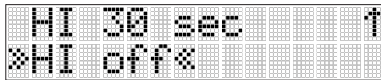

Pic 33 HI Alert off

### 18.3 Backlight (RC1402 only)

**WHY:** Under dark ambient light conditions, the display is often hard to read. A backlight helps to read the display from the remote control. Using the backlight too long reduces battery lifetime.

**WHAT:** The remote display provides a backlight to read the display easily. Depending on the need of good visibility for the backlight or saving the battery life, the remote control provides two different times to shut off the backlight. The times are 8 seconds (default) or 60 seconds.

**HOW:** Press the M button (h) to enter the menu, scroll to >>Settings<<, press E button (j) to enter the sub menu. Scroll to >>Backlight<< and press E button (j) to enter the sub menu. Choose backlight time 8 seconds (default) or 60 seconds. Press E button (j) to confirm the selection.

**>>8 seconds<< (default)**

**>>60 seconds<<**

### 18.4 Sensitivity

**WHY:** The job site conditions might be different as well as the requirements according to accuracy. On some job sites there are a lot of vibrations caused by machines or the weather is stormy and there is a lot of wind.

WHAT: The HV1305C/HV1305GC provides different levels of sensitivity depending on the job site conditions. In all levels of sensitivity, the laser will level to the most accurate level value. Nevertheless, the tolerance allowing for a disturbance by vibration or wind will be different. The three different levels of sensitivity provided by the HV1305C/HV1305GC are “low” to work with high wind and vibrations, “middle” to work under normal job site conditions (default) and “high” to work in very calm conditions.

HOW: Press M button (h) on the remote control to enter the menu, scroll to >>Settings<< and press E button (j) to enter the sub menu. Scroll to >>Sensitivity<<, and press E button (j) again to enter the sub menu. Choose the desired level of sensitivity >>Low<<, >>Middle<< (default), or >>High<<.

**>>Low<<**  
**>>Middle<<**  
**>>High<<**

## 18.5 Language

WHY: The company using the HV1305C/HV1305GC may have employees from different countries. The laser may be shifted from one person to another, each with a different native language. Each person on a job site using the HV1305C/HV1305GC wants to use the laser in the known language.

WHAT: The HV1305C/HV1305GC provides via the remote control many different languages for the interface. Choose the language to feel the most comfortable with. Standard language is English. Using the laser remote app with the laser requires no change of the language for the app. The laser remote app will use the language that is used for the smart phone when this language is supported by the laser. If the smart phone uses a language that is not supported by the laser, the laser remote app uses English as the language.

HOW: Press M button (h) to enter the remote-control menu. Scroll to >>Settings<< and press the E button (j) to enter the sub-menu. Using UP/DOWN buttons (f) scroll to >>Language<<, see pic 34. Press E button (j) to enter the sub-menu. Scroll to the language, select the language moving these >> << symbols by scrolling and press E button (j) to confirm.

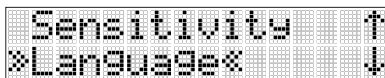

Pic 34 Language Menu

<b>&gt;&gt;English&lt;&lt;</b>	<b>&gt;&gt;Deutsch&lt;&lt;</b>
<b>&gt;&gt;Italiano&lt;&lt;</b>	<b>&gt;&gt;Francais&lt;&lt;</b>
<b>&gt;&gt;Español&lt;&lt;</b>	<b>&gt;&gt;Portugues&lt;&lt;</b>
<b>&gt;&gt;Nederlands&lt;&lt;</b>	<b>&gt;&gt;Dansk&lt;&lt;</b>
<b>&gt;&gt;Norsk&lt;&lt;</b>	<b>&gt;&gt;Svenska&lt;&lt;</b>
<b>&gt;&gt;Suomi&lt;&lt;</b>	<b>&gt;&gt;Polski&lt;&lt;</b>
<b>&gt;&gt;Turkce&lt;&lt;</b>	<b>&gt;&gt;Cestina&lt;&lt;</b>

## 18.6 Radio Channel

**WHY:** The laser HV1305C/HV1305GC is using radio communication between the laser and the remote control. Using PlaneLok and PlaneMatch there is radio communication between the laser and the receiver HL760 / CR700. On job sites there can be some radio pollution within some of the radio channels. When radio communication is not working properly, one solution to fix the problem can be to change the radio channel to use a radio channel that is more open.

**WHAT:** The HV1305C/HV1305GC provides six different radio channels. Those are 0 (default), 1, 2, 3, 4 and 5.

**HOW:** The radio channel can be changed only using the remote control! Press M button (h) on the remote control to enter the menu. Scroll to >>Radio Channel<<, see pic 35 and press the E button (j) to open the sub menu. The desired radio channel 0 to 5 can be selected by scrolling the >> << symbols using the UP/DOWN (f) buttons. Press the E button (j) to confirm the selected radio channel.

**Note:** After changing the radio channel on the laser, the remote control RC1402 and the HL760 / CR700 must be paired again. During the pairing process, they will adapt to the new radio channel.

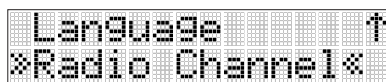

Pic 35 Radio channel menu

>>0<<  
>>1<<  
>>2<<  
>>3<<  
>>4<<  
>>5<<

## 19 Info (only via RC1402 Remote Control)

**WHY:** The info menu provides some information about the laser. This information can be helpful for any communication with your dealer or service technician when a problem occurs with the laser during usage. This can be misbehavior on any features and functions, a problem in radio communication between laser, remote control, or laser receiver.

The run time of the laser can be reviewed here as well. This can be helpful for rental purposes.

WHAT: Information about the laser is laser model number (HV1305C or HV1305GC), battery status, temperature within the laser in °C and °F, PWR-Firmware revision, SENS-Firmware revision, RADIO-Firmware revision, and the internal serial number (SN) in HEX-code that is different to the serial number printed on the serial label.

Information about the runtime of the laser. This is the time the laser has been used since it was produced. The runtime is shown in hours and minutes. It cannot be set to zero.

Information about the current radio channel that has been selected for the communication path.

HOW: Press the M button (h) on the remote control to enter the menu; using the UP/DOWN buttons (f) scroll to >>Info<< (pic 36). Press E button (j) to enter the Info sub-menu. Scroll to >>About LS<< (pic 37) and press E button (j) to enter the sub-menu. Scroll to >>Runtime<< (pic 37) and press E button (j) to see the current runtime. Scroll to >>Radio<< (pic 52) and press E button (j) to show the current used radio channel.

Sub-menus in >>About LS<<:

Scroll to >>Model<< (pic 38) and press E button (j) to read the model number of the laser (pic 39).

Scroll to >>Battery<< (pic 40) and press E button (j) to show the battery status of the laser: Good. Weak. Empty; see pic 41.

Scroll to >>Temperature>>, see pic 42 and press E button (j) to show the current temperature within the product in °C and °F (pic 43).

**Note:** This is the internal product temperature, and this can be different to the ambient temperature.

Scroll to >>PWR-Firmware<< (pic 44) and press E button (j) to read out the revision of the PWR-Firmware (pic 45).

Scroll to >>SENS-Firmware<< (pic 46) and press E button (j) to read out the SENS-Firmware revision.

Scroll to >>RADIO-Firmware<< (pic 47) and press E button (j) to read out the SENS-Firmware revision.

Scroll to >>Serial Number<< (pic 48) and press E button (j) to read out the internal serial number of the laser in HEX code (pic 49).

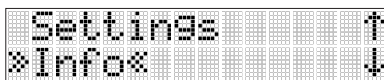

Pic 36 Info menu

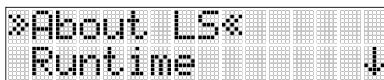

Pic 37 About laser menu



```
Model
Battery ↓
```

Pic 38 Model number menu

```
Model HV1305C | Model HV13056C
```

Pic 39 Model number

```
Model
Battery ↓
```

Pic 40 Battery menu

```
Battery Status
Good
```

Pic 41 Battery status good

```
Temperature ↑
PWR-FW-REV ↓
```

Pic 42 Temperature menu

```
Temperature
21°C / 70°F
```

Pic 43 Laser temperature °C / °F

```
Temperature ↑
PWR-FW-REV ↓
```

Pic 44 PWR-Firmware menu

```
PWR-FW-REV
01.000
```

Pic 45 PWR-Firmware revision

```
SENS-FW-REV ↑
RADIO-FW-REV ↓
```

Pic 46 Sens Firmware menu

```
SENS-FW-REV ↑
RADIO-FW-REV ↓
```

Pic 47 Radio firmware menu

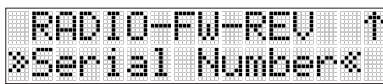

RADIO-FW-REV ↑  
\*Serial Number\*

Pic 48 Serial number menu

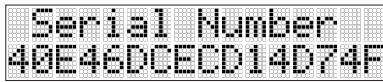

Serial Number  
40E46DCECD14D74F

Pic 49 Laser serial number

In menu >>Runtime<<, see pic 50, press E button (j) to enter the menu and to see the current runtime of the laser, see pic 51.

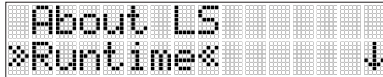

About LS  
\*Runtime\* ↓

Pic 50 Runtime menu

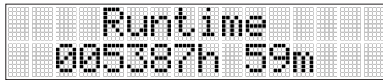

Runtime  
005387h 59m

Pic 51 Laser Runtime

In menu >>Radio<<, see pic 52, press E button (j) to enter the menu to read the channel number, see pic 53.

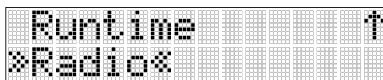

Runtime ↑  
\*Radio\*

Pic 52 Radio channel menu



RF Channel = 0

Pic 53 Radio channel

## 20 Determining the Height of Instrument (HI)

**WHY:** For most applications it is necessary that the height of instrument (HI) is known because it is used as a reference height and control elevation on a regular basis.

**WHAT:** The height of instrument (HI) is the elevation of the laser beam in relation to a benchmark or reference point. The HI is determined by adding the grade-rod reading to a benchmark or known elevation.

**HOW:** Set up the laser and place the grade-rod on a jobsite benchmark (BM) or known elevation. Slide the receiver up or down the grade-rod until it shows an on-grade reading. Add the grade-rod reading to the benchmark to determine the height of instrument

Example:

Benchmark = 30.55m (100.23ft)

Rod reading = +1.32m (4.34ft)

Height of instrument = 31.87m (104.57ft)

Use this HI as a reference for all other elevations.

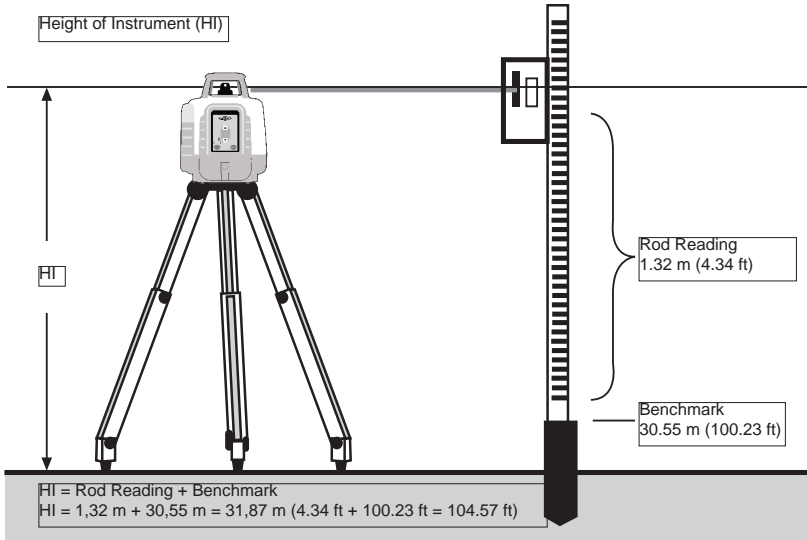

## 21 Vertical Application

### 21.1 Vertical Automatic Mode

#### 21.1.1 Vertical Alignment / Laser Line Position

**WHY:** On many job sites and applications, two reference points need to align to each other. Between the two reference points a trench can be excavated or any vertical setup is needed to install formwork, fences, or similar things.

**WHAT:** In vertical automatic mode the laser provides a laser plane that is leveled vertical (along the Y axis) and can be adjusted horizontal (along the X axis).

**HOW:** The unit is in vertical position in the automatic mode (see pic 54). In this mode, pressing the RIGHT/LEFT arrow buttons (g) will align the position of the laser plane in the direction of the X axis. Pressing the right arrow button the laser plane moves to the right in the X axis. Pressing the left arrow button moves the laser plane to the left in the X axis.

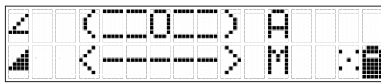

Pic 54 Vertical automatic mode

**Note:** In vertical automatic mode, the X axis is always in manual mode and there is no sensor that watches this axis. Even when the product is designed to avoid unforeseen drift as much as possible, there is the risk of a drift for any reason that the user must overlook on its own responsibility. It is mandatory that the user watches the laser plane in X axis for any unforeseen behavior since there is no warning for the position or any changes caused by wind, vibrations, or temperature changes.

### 21.1.2 Line Scan

**WHY:** For many applications, it is helpful to have the laser centered to the housing in vertical to start with the alignment. The Line Scan function helps to center the rotor in relation to the housing.

**WHAT:** When setting up the laser vertically, Line Scan centers the rotor horizontally and can be used to align the laser reference to a desired line position. Activation of line scan can be done by two different options, see below. The rotor checks the limits of the X axis (laser beam is flashing, all laser LEDs are turned off) and stops at the center position.

**HOW:**

**Option 1:** Pressing the LEFT/RIGHT arrow buttons (g) simultaneously starts the Line Scan, see pic 56, while the rotor will finally stop at the center position. Pressing the manual button (c) stops the movement and changes the laser into manual mode (pic 57). Corrections left and right can be done using LEFT/RIGHT arrow buttons (g). Press and release the manual button (c) to change the unit back to fully automatic mode.

**Option 2:** Press M button (h) on the remote control to enter the menu. Scroll to >>Line Scan<< (pic 55) and press E button (j) to start the function (pic 56). Pressing the manual button (c) stops the movement and changes the unit into manual mode, (pic 57). Corrections left and right can be done using LEFT/RIGHT arrow buttons (g). Press manual button (h) again to change the unit back to fully automatic mode.

**Note:** In vertical automatic mode, the X axis is always in manual mode and there is no sensor that watches this axis. Even when the product is designed to avoid unforeseen drift as much as possible, there is the risk of a drift for any reason that the user must overlook on its own responsibility. It is mandatory that the user watches the laser plane in X axis for any unforeseen behavior since there is no warning for the position or any changes caused by wind, vibrations, or temperature changes.

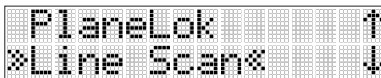

Pic 55 Line scan mode

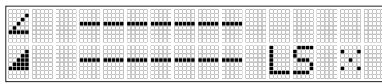

Pic 56 Line scan in progress

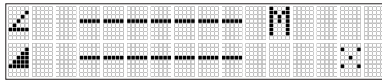

Pic 57 Line position mode

### 21.1.3 Automatic Plumb Down

**WHY:** In vertical set-up the laser beam needs to be positioned over a reference point when the laser is on a tripod or on a batter board.

**WHAT:** Automatic plumb down automatically drives the laser beam to the plumb down position when the rotation speed is 0 rpm with an accuracy that is described in chapter 32.1.

**HOW:** Set up the laser vertically on a flat surface, a tripod or on a batter board using the batter board clamp M402. Change rotation speed to 0 rpm. How to change rotation speed, see chapter 10.

**Note:** Using the up and down arrow buttons (f) you can point the laser beam to another position. After approximately three seconds the laser beam will go back to the plumb down position again.

**Note:** Change the laser into line scan mode and move the scan using the up and down arrow buttons (f) to move the scan where you need to work with.

**Note:** Limitation for maximum roll to use the automatic plumb down see chapter 32.1

**Note:** There is no automatic plumb down in manual mode.

### 21.1.4 Beam Plunge

**WHAT:** Beam Plunge centers the rotor vertically and can be used to align the plumb beam to a desired vertical position, e.g., when doing interior layout.

**HOW:** Press and release the M button (h) on the remote control and scroll to >>Beam Plunge<<. Pressing and releasing the E button (j) activates the Beam Plunge mode (see pic 58) while the rotor checks the limits of the Y axis and switches back to automatic mode at the center position. Pressing the manual button (c) stops the movement and changes the unit into manual mode. Corrections up and down can be done using the arrow buttons Up/Down (f). For left/right corrections use the arrow buttons Left/Right (g). Press and release the manual button (c) to change the unit back to fully automatic mode.

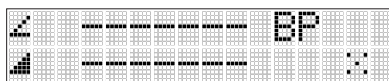

Pic 58 Beam Plunge

### 21.1.5 PlaneLok in Vertical

See chapter 17

### 21.2 Manual Mode Vertical

HOW: When the unit is in vertical automatic mode, press the manual button (c) to switch into vertical manual mode.

Now the laser plane can be adjusted using the UP/DOWN arrow buttons (f) for the Y axis or using the LEFT/RIGHT arrow buttons (g) for the X axis.

When the rotation speed is changed to 0 rpm, the non-rotating laser moves into a 90°-to-the-side-position. Using the up- or down-arrow buttons (f) the laser beam can be positioned to any position. After a mode change to automatic mode or horizontal set-up and bringing the laser back into manual vertical position will drive the non-rotating laser beam again to the 90° position.

**Note:** In vertical manual mode, both the X axis and Y axis are always in manual mode and there is no sensor that watches the axis. Even when the product is designed to avoid unforeseen drift as much as possible, there is the risk of a drift for any reason that the user must overlook on its own responsibility. It is mandatory that the user watches the laser plane in X- and Y axis for any unforeseen behavior since there is no warning for the position or any changes caused by wind, vibrations, or temperature changes.

**Note:** For manual mode in horizontal see chapter 9.

**Note:** There is no automatic plumb down when the unit is in manual mode.

## 22 Applications, Interior

### 22.1 Acoustical Ceilings

1. Determine and mark the finished ceiling height and securely install the first piece of wall molding to this height.
2. Attach the laser onto the wall molding by sliding the wall mount over the wall molding and turn the locking screws until the wall mount is secured.
3. Make sure the locking knob on the wall mount is loose.
4. To adjust the elevation, turn the fine height adjustment screw until the slider edge is at the zero (0) mark on the scale (wall molding elevation), and turn the locking knob to tighten it.



## 22.2 Drywall and Partitions

Slide the slider edge along the elevation scale to the short line at the scale above the 0-mark.

1. Place the laser over the near wall control point.

**Note:** If the wall mount is attached to the floor track, make sure the laser is set to the edge of the track (0-mark).

2. Use the left / right arrow button (g) to point the beam towards the far wall control point.
3. Go to the far wall-control point and use the remote control to adjust the line of the laser until the laser beam is aligned to the mark.



**Note:** If you're using the perpendicular beam for alignment, use the RC1402 menu to activate the Beam Plunge function to move the perpendicular beam to your far wall control mark.

**Note:** When the laser beam is on the mark, press the manual button (c), then use the left and right arrow buttons (g) for the left and right adjustment.

**Note:** After line adjustment is completed, press the manual button (c) so the laser will automatically re-level.

4. Install the track or mark the track line on both the floor and ceiling for future track installation.

## 23 Use Receiver

### 23.1 Pair the laser with HL760 receiver

**WHY:** To use automatic functions like PlaneMatch or PlaneLok, the laser and the HL760 need to be paired so they can communicate with each other.

**WHAT:** The pairing of the laser and the receiver will establish a radio communication between the laser and the receiver which is only used for this combination.

**HOW:** Make sure the laser is turned off.

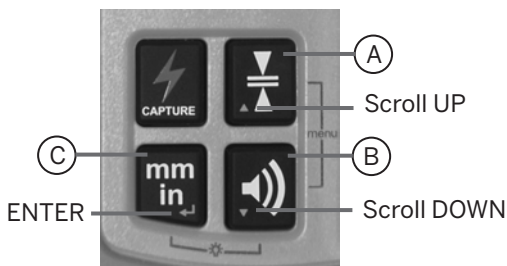

First, turn on the receiver, then press and hold the scroll up (A) and scroll down (B) button for two seconds simultaneously. After two seconds, the display shows MENU first, then RDIO. Press and release the Enter button (C). The display shows the current radio mode. Mode LS means the receiver is ready to pair with a compatible laser; Mode HL means the receiver is ready to pair with another HL760 or CR700; Mode OF means the radio function of the receiver is disabled.

If the display does not show Mode LS, press Units button (C). The current mode flashes, now press dead band button (A) or audio button (B) until LS is flashing.

Press Units button (C) button to enter selection.

Press and release the Audio button (A) to display "PAIR".

Press the Units button (C) again to start the pairing process; the display shows a rotating bar. The HL760 is now in pairing mode.

On the laser, press and hold the Manual button (c) and turn on the laser. The laser starts and a fast-flashing Battery LED (b) indicates that the laser is in pairing mode. After completing PAIR OK will be displayed on the receiver and a long beep occurs.



The HV1305C/HV1305GC has been paired with this receiver and turns back to the standard function. On the HL760 press and release the power button twice to exit the menu at the receiver. A laser symbol and an antenna are lit to confirm the receiver is ready for communication with the laser.

**Note:** The laser with antenna symbol in the display is the indication for the connection status of receiver and laser. When an automatic function with laser and receiver fails, the missing symbol is a first indication of a root cause. When the symbol is missing this can be the reason:

- The laser is off. Check the laser, it may have shut off for some reason. Turn it on and check if the symbols will come back after a few seconds.
- The laser is not paired with the receiver. Maybe this laser was paired with the receiver before but for some reason the pairing has been lost. Start the pairing process described in this chapter.

## 23.2 Pair the Laser with CR700

Make sure the laser is turned off.

First turn on the CR700, press the power (menu) button quickly, scroll to RDIO menu. Make sure RDIO LS is shown. If not, press the enter button: symbol starts to blink. Scroll until LS is blinking. Press the enter button. Make

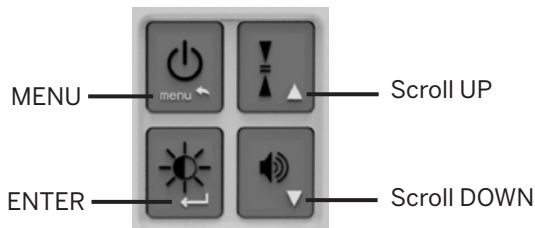



sure LS is no longer blinking. Scroll to PAIR. Press the enter button. CR700 is now in pairing mode.

Now continue with the laser. Press and hold the Manual button (c) on the laser and turn on the laser. The laser starts and a fast-flashing Battery LED (b) indicates that the laser is in pairing mode. After completing PAIR, OK will be displayed on the receiver and a long beep occurs.

The HV1305C/HV1305GC has been paired with this receiver and turns back to the standard function. On the CR700 press and release the power button once to exit the menu. A laser symbol and an antenna are lit to confirm the receiver is ready for communication with the laser.

**Note:** The laser with antenna symbol in the display is an indication for the connection status of receiver and laser. When an automatic function with laser and receiver fails, the missing symbol is a first indication of a root cause. When the symbol is missing this can be the reason:

- The laser is off. Check the laser, it may have shut off for some reason. Turn it on and check if the symbols will come back after a few seconds.
- The laser is not paired with the receiver. Maybe this laser was paired with the receiver before but for some reason the pairing has been lost. Start the pairing process described in this chapter.

## 24 Remote Control RC1402

### 24.1 Powering the RC1402

- Open the battery door using a coin or similar pry device to release the battery door tab on the RC1402.
- Insert two AA batteries noting the plus (+) and minus (-) diagrams inside the battery housing. Rechargeable batteries can be used optional but need to be charged externally.
- Close the battery door. Push down until it “clicks” into the locked position.



## 24.2 Turning On/Off The Radio Remote Control RC1402

The radio remote control is a hand-held device that allows you to send operational commands to the laser from a remote location.

Press the power button to turn on the radio remote control.

To turn off the radio remote control, press and hold the power button for two seconds.

When the remote control is initially turned on, the standard display (model number and software version) appears for the first three seconds (see pic 59) then the RC1402 LCD shows the current laser function. This standard display is also shown when the RC1402 is out of operating range or not paired with the laser or the paired laser is not switched on.

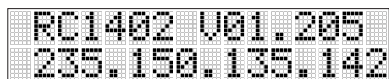

Pic 59 RC1402 standard display

With every button press, the LCD backlight is activated and turns off automatically if no button is pressed for 8 seconds or 60 seconds depending on the settings. How to change the settings for the backlight, see chapter 18.3

**Note:** Five minutes after the last button press, the remote control turns off automatically to save battery.

## 24.3 Pairing The Remote Control RC1402 With The Laser

**WHY:** The communication between remote control RC1402 and the laser HV1305C/HV1305GC is based on a radio communication path. This enables a unique communication path that ensures only the paired laser will be controlled by the paired remote control.

**WHAT:** When the pairing has been lost for some reason, when the radio channel has been changed or when the remote has been replaced, the pairing needs to be reestablished.

**HOW:** First, make sure the laser and the remote control are turned off. Start with the laser pressing and holding the Manual button when turning on the laser. Now the laser is in pairing mode for the next six seconds. Within this time frame continue with the remote control. Press and hold the manual button on the remote control and turn on the remote control.

The laser beeps and the remote's display show 'Pairing OK' (see pic 60) for one second and then the display shows the current working mode.

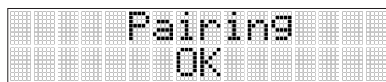

Pic 60 Pairing OK

## 24.4 RC1402 Menu Navigation

Press and release 'M' button to enter the Menu.

The actual available function will be marked in arrow brackets >> <<. A down or up arrow at the right sites indicates that the user can scroll up/down through the menu using the 'Up/Down' arrow buttons. Press and release button 'E' to open the submenu or start the selected function.

Press and release button 'M' changes the unit always back to the previous or standard display.

Press and release the 'Up/Down' buttons until the desired function at the selected menu row is marked.

Menu functions for the HV1305C/HV1305GC:

>>Rotation<<  
>>Scan<<  
>>PlaneMatch<<  
>>PlaneLok<<  
>>Single Slope<<  
>>Mask Mode<<  
>>Settings<<  
>>Info<<  
>>Service

## 25 Troubleshooting

Any error message at the remote control RC1402 or the app can be confirmed with a short press on the button E or on the OK (app). The table below shows the related description and possible solutions. The laser or remote control shows a string of numbers where only the last two or three digits are needed for the error code list below. Using the laser remote app, the text shown below will be provided directly through the app depending on the error code.

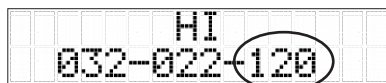

Pic 61 Example error code shock warning

The next service center should be contacted if a different error message as shown on the table will be displayed.

Error code	Description	Solution
030	PWR-Board data recovered	Press E button (j) on the remote control or OK button in the app to confirm the error message. The laser has changed to default settings. You may need to redo your personal settings. The laser may have lost the pairing to the remote control, to the HL760/CR700 or the smartphone. Please check. You may need to redo the pairing.
035	SENS-Board data recovered	Press E button (j) on the remote control or OK button in the app to confirm the error message. It is recommended to check the laser accuracy.
120	HI-alert – Unit height has changed	Press E button (j) on the remote control or the OK button in the app to delete the error message. Check Laser Beam Elevation and Laser Setup.
130	Mechanical Limit during PlaneMatch / PlaneLok	Press E button (j) on the remote control or the OK button in the app to delete the error message. Check if the receiver was set out of the slope range (+/- 9%, 5°).
135	Error - Cross Axis Compensation Limitation	Avoid too much roll for the laser; re-setup the laser with less roll and restart the function.
140	Laser beam blocked	Press E button (j) on the remote control or the OK button in the app to delete the error message. Make sure there are no obstacles between the laser and HL760/CR700 receiver during the operation. The receiver needs to receive the laser beam all the time during this function.
141	Time out – Alignment could not be completed in the allowed time.	Press E button (j) on the remote control or the OK button in the app to delete the error message. Check radio operating range / connection. Check if the laser setup is stable.
150	No receiver – HL760 Receiver not available for single axis automatic function	Press E button (j) on the remote control or the OK button in the app to delete the error message. Make sure the HL760/CR700 has been switched on and is paired with the laser. The HL760/CR700 may have turned off automatically. Check if the receiver is within radio range.
152	No receiver - The laser searched for the receiver but could not find it	Press E button (j) on remote control or the OK button in the app to delete the error message. Check the operating range for auto function and restart the function. The receiver has been placed too far away, too high, or too low. Check if the receiver has been placed along the wrong axis. If so place the receiver along the correct axis.

153	Lost receiver - The laser searched and found the receiver but then lost it.	Press E button (j) on the remote control or the OK button in the app to delete the error message. Check the operating range for auto function and restart the function. The receiver has been placed too far away, too high, or too low. Check if the receiver has been placed along the wrong axis. If so place the receiver along the correct axis.
155	More than one paired receiver is available during automatic alignment function.	Press E button (j) on the remote control or the OK button in the app to delete the error message. Make sure only one receiver is turned on.
157	After an established and started receiver operation this error indicates a lost communication.	Press E button (j) on the remote control or the OK button in the app to delete the error message. Check the operating range for auto function and restart the function. The receiver has been placed too far away.
160	X or Y level sensor defect	Contact your service dealer.

## 26 Check Accuracy

### 26.1 Checking accuracy of the Y- and X Axis

1. Set up the laser 30 m (100 ft.) from a wall and allow it to level.
2. Raise/lower the receiver until you get an on-grade reading for the +Y axis. Using the on-grade marking notch of the receiver as a reference, make a mark on the wall.

**Note:** For increased precision, use the ultra-fine sensitivity setting (0.5 mm / 1/32in) on the receiver.

3. Rotate the laser 180° (-Y axis towards the wall) and allow the laser to re-level.
4. Raise/lower the receiver until you get an on-grade reading for the -Y axis. Using the on-grade marking notch as a reference, make a mark on the wall.
5. Measure the difference between the two marks. If they differ more than 3 mm at 30 m (1/8 inch at 100 feet), the laser needs calibrating.
6. After checking the Y axis, rotate the laser 90°. Repeat the above starting with the +X axis facing the wall.

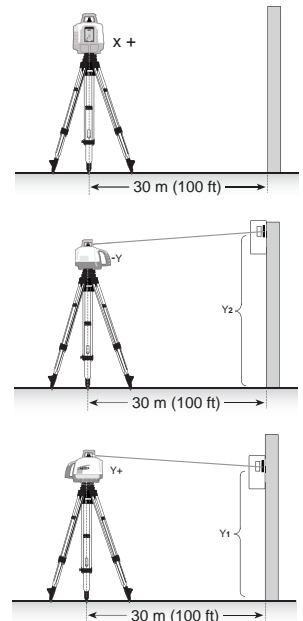

## 26.2 Checking accuracy of the Z Axis (vertical)

To check vertical calibration, you need a plumb bob with a 10 m (30 ft.) of string.

1. Suspend the plumb bob in front of a house i.e., attached to a window frame whose window height is at least 10 m (30 ft.).
2. Set up the laser vertically so that the laser beam strikes the receiver's on-grade position at the top of the string.
3. Look for any deviation using the receiver from the top of the string to the bottom of it. If the deviation is more than 1 mm (1/16 in), the vertical axis needs calibrating.

## 27 Service

### 27.1 Technician Menu

Access to Technician menu, see pic 62, is only possible for trained service dealer personnel.

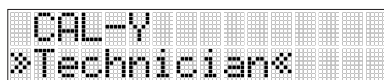

62 Technician menu

## 28 Protect the Unit

Do not expose the unit to extreme temperatures or temperature changes (do not leave inside the car). The unit is very robust and can resist damage if dropped even from tripod height. Before continuing your work, always check the leveling accuracy. See section 26 Check Accuracy.

The laser can be used indoors and outdoors.

## 29 Cleaning and Maintenance

Dirt and water on the glass parts of the laser will influence beam quality and operating range considerably. Clean with cotton swabs.

Remove dirt from the housing with a lint-free, warm, wet and smooth cloth. Do not use harsh cleaners or solvents.

Allow the unit to air dry after cleaning it. Never put the unit wet into the carrying case for storage.

## 30 Protecting the Environment

The unit, accessories, and packaging ought to be recycled.

All plastic parts are marked for recycling according to material type.

**Note:** Do not throw used batteries into the garbage, water, or fire. Remove them in compliance with local environmental requirements.

## **31 Warranty**

Spectra Precision LLC warrants the HV1305C/HV1305GC to be free of defects in material and workmanship for a period of five years. Spectra Precision LLC or its authorized service center will repair or replace, at its option, any defective part, or the entire product, for which notice has been given during the warranty period. If required, travel and per diem expenses to and from the place where repairs are made will be charged to the customer at the prevailing rates. Customers should send the product to the nearest authorized service center for warranty repairs or exchange, freight prepaid. Any evidence of negligent, abnormal use, accident, or any attempt to repair the product by other than factory-authorized personnel using Spectra Precision LLC certified or recommended parts, automatically voids the warranty. Special precautions have been taken to ensure the calibration of the laser; however, calibration is not covered by this warranty. Maintenance of the calibration is the responsibility of the user.

The foregoing states the entire liability of Spectra Precision LLC regarding the purchase and use of its equipment. Spectra Precision LLC will not be held responsible for any consequential loss or damage of any kind. This warranty is in lieu of all other warranties, except as set forth above, including any implied warranty merchantability of fitness for a particular purpose, are hereby disclaimed. This warranty is in lieu of all other warranties, expressed or implied.

## 32 Technical Specification

### 32.1 Technical Specification HV1305C/HV1305GC Laser

Leveling Accuracy <sup>1,2</sup> , Vertical, Horizontal	± 1,5mm / 30m; 1/16 in @ 100ft; 10 arc seconds
Rotation Speed <sup>1</sup>	0, 10, 100, 200, 300 and 600 rpm
Operational Diameter <sup>1,3</sup> with HL760 (not with HV1305GC Laser Class 2)	Up to 1200 m (4000 ft)
PlaneMatch Distance	Up to 80 m (260 ft)
PlaneLok Distance	Up to 80 m (260 ft)
Laser Type	510 – 530 nm / 630 – 643 nm
Automatic Plumb Down Accuracy	15 arc min; 5 mm @ 1 m (1/4 in @ 4 ft)
Plumb Down Roll Limitation	± 8°
Laser Class	Class 3 or Class 2 (Class 2 available in EU)
Self-Leveling Range	Typ. ± 5° (± 8.7%)
Radio Range (HL760) <sup>1,3,4</sup>	Up to 100m (330 ft)
Operating Temperature (inside product temperature)	-20°C to +50°C (-4°F to +122°F)
Storage Temperature	-25°C to +70°C (-13°F to +158°F)
Power Source	10000mAh NiMH battery back or 4 x 1.5V D alkaline batteries
Battery Lifetime (NiMH)	HV1305C typ. 45 hours HV1305GC typ. 30 hours
Battery Charging Time	< 10 hours
Battery Charging Temperature	5°C to +40°C (+41°F to +104°F)
Charger Input Voltage	100V-240VAC ± 10%, 50 Hz – 60 Hz
Tripod Attachments	5/8 x 11 horizontally and vertically
Dust and Water Proof (IP)	IP66
Max. Humidity	90%
Over Voltage Category	I
Pollution Degree	2
Weight	3.49 kg (7.7 lbs) (incl. Battery pack)
Product Dimensions	240mm x 280mm x 180mm (9.45 in x 11.02 in x 7.09 in)

1 at 21°C / 70°F

2 along the axis

3 under optimal atmospheric circumstances

4 when product is set up at a height of min. 1m / 3ft



## 32.2 Technical Specification RC1402 Remote Control

Radio Operating Range <sup>1,3,4</sup>	Up to 100m (330ft)
Power Source	2 x 1.5V AA alkaline batteries
Battery Life <sup>1</sup>	Typ. 130 hours
Dust and Waterproof	IP66
Weigh (without batteries)	0,124kg (0.27lbs)

<sup>1</sup> at 21°C / 70°F

<sup>2</sup> along the axis

<sup>3</sup> under optimal atmospheric circumstances

<sup>4</sup> when product is set up at a height of min. 1m / 3ft

## 33 Declaration of Conformity

We

Spectra Precision (Kaiserslautern) GmbH

declare under our sole responsibility that the products

HV1305C/HV1305GC and optional RC1402

to which this declaration relates is in conformity with the following standards:

EN 55014-1:2017, EN 55014-2:2015, EN 60825-1:2014 + Amdt., EN 61010-1:2010 + Amdt., EN IEC 62311:2020, ETSI EN 300328 V2.2.2:2019, ETSI EN 301489-1 V2.2.3:2019, ETSI EN 301489-17 V3.2.4:2020

Applied European directives: 2011/65/EU RoHS Directive, 2014/53/EU Radio Equipment Directive

## 34 UKCA

We We declare under our sole responsibility that the products HV1305C/HV1305GC and RC1402 are in conformity with the following relevant UK Statutory Instruments:

2012 No. 3032 The Restriction of the Use of Certain Hazardous Sub-stances in Electrical and Electronic Equipment (RoHS)

2017 No. 1206 The Radio Equipment Regulations

Relevant designated standards:

EN 55014-1:2017, EN 55014-2:2015, EN 60825-1:2014 + Amdt., EN 61010-1:2010 + Amdt., EN IEC 62311:2020, ETSI EN 300328 V2.2.2:2019, ETSI EN 301489-1 V2.2.3:2019, ETSI EN 301489-17 V3.2.4:2020

## **35 Electro-Magnetic Compatibility**

Compliance statement (part 15.19): This device complies with part 15 of the FCC Rules. Operations is subject to the following tow conditions: (1) this device may not cause harmful interference, and (2) this device must accept any interference received, including interference that may cause undesired operation.

Warning (part 15.21): Changes or modifications not expressly approved by the party responsible for compliance could void the user's authority to operate the equipment. This in particular is applicable for the antenna, which has been delivered with the HV1305C/HV1305GC and RC1402. Under Industry Canada regulations, this radio transmitter may only operate using an antenna of a type and maximum (or lesser) gain approved for the transmitter by Industry Canada. To reduce potential radio interference to other users, the antenna type and its gain should be so chosen that the equivalent isotropically radiated power (e.i.r.p.) is not more than that necessary for successful communication.





Spectra Precision (USA) LLC  
3265 Logistics Lane, Suite 200  
Dayton, OH 45377  
U.S.A.  
Phone +1 888-527-3771

Spectra Precision (Kaiserslautern) GmbH  
Am Sportplatz 5  
67661 Kaiserslautern  
GERMANY  
Phone +49-6301-711414

[spectraprecision.com](https://www.spectraprecision.com)

